

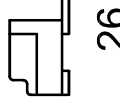

HYDRO

1

26



26

3

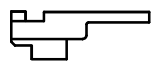

26

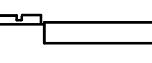

26

2

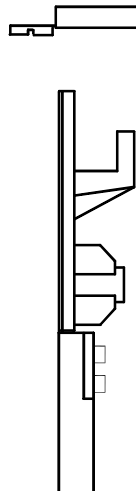

4

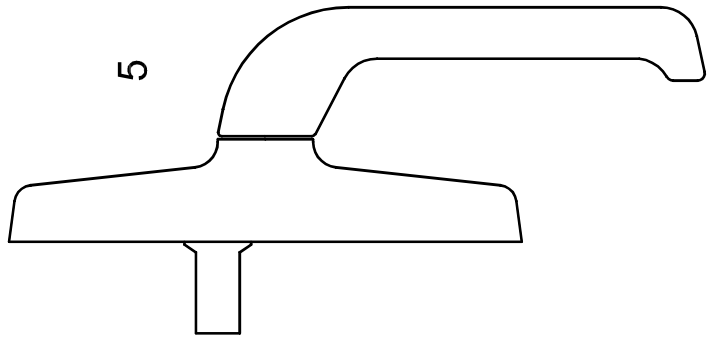
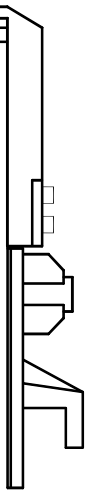

5

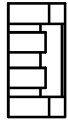

25



13

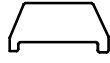

14



23



6

7

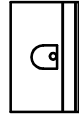

17



24



8

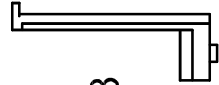



HYDRO

Piezas que forman el Herraje Oscilo-Batiente

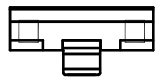
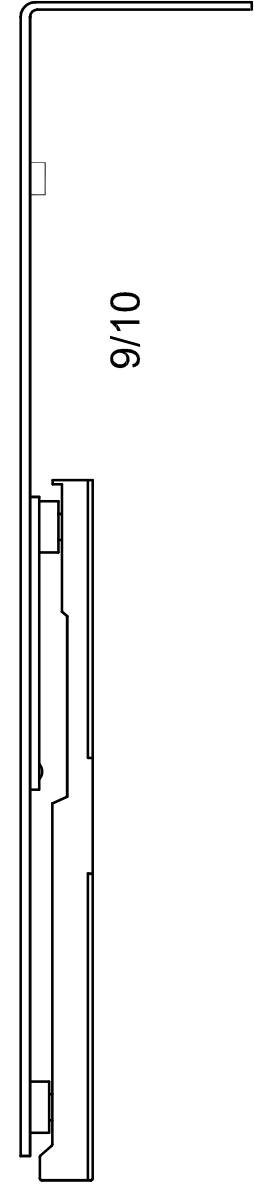

11

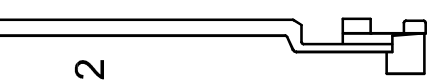

12

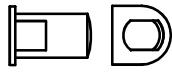

18

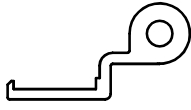

19

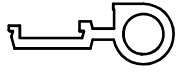

21

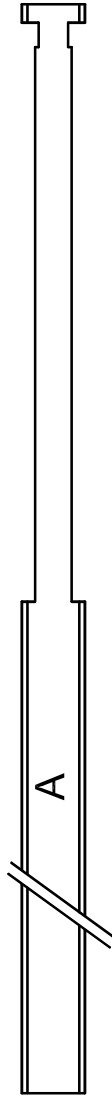

16

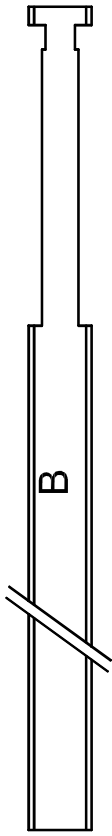

15

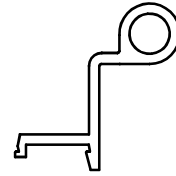

20

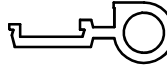

22

Herraje oscilo-batiente Lado cremona

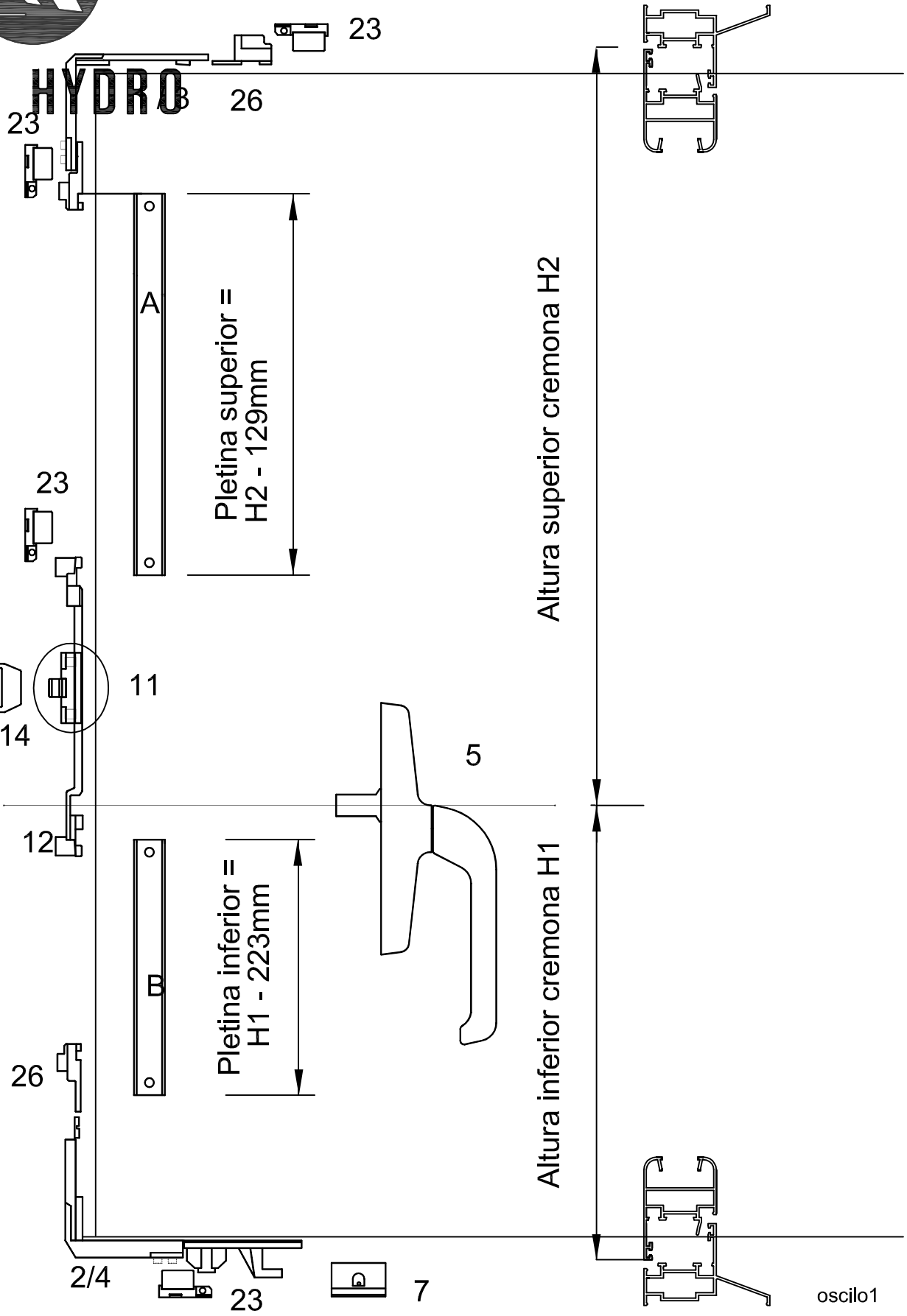

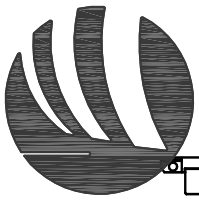

Herraje oscilo-batiente Lado bisagras

HYDRO

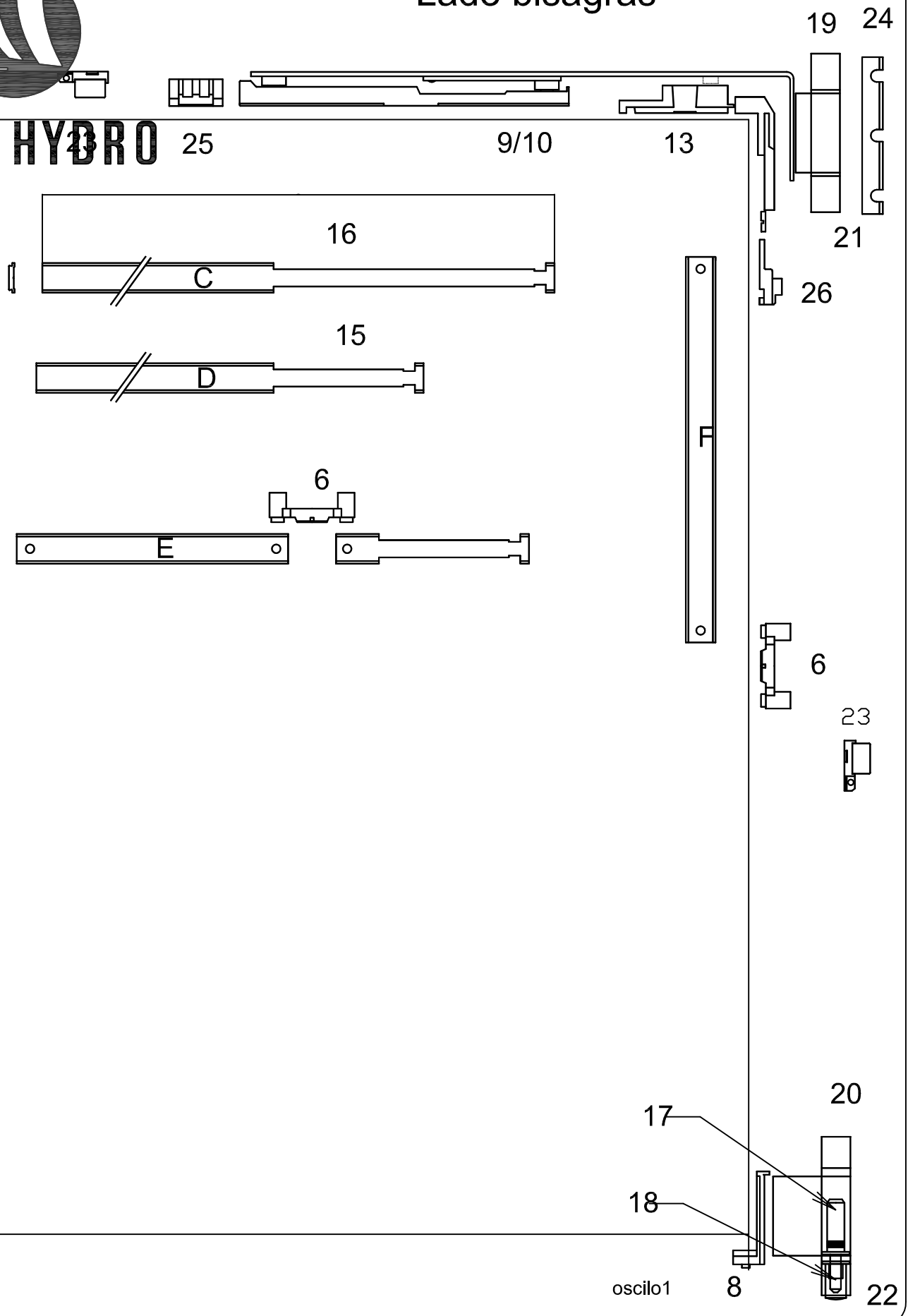

oscilo1